

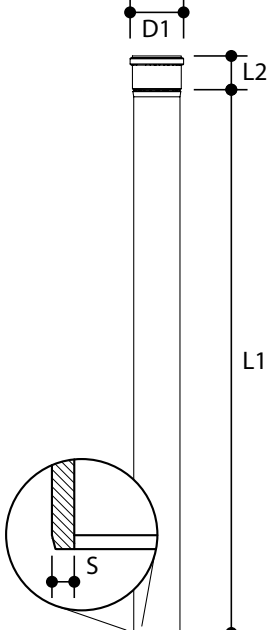









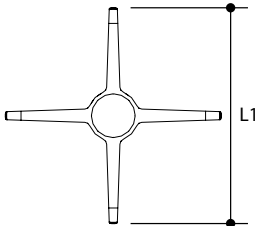

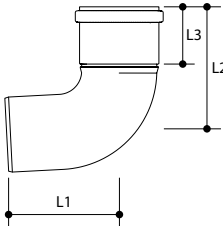

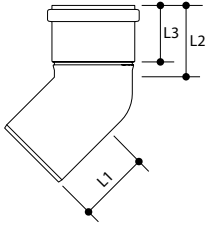

Planungs- und Montageanleitung „Abgasleitung aus Kunststoff“ - Einfachbelegung -

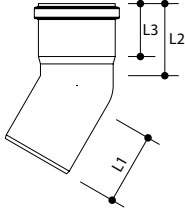

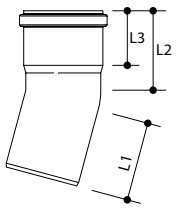

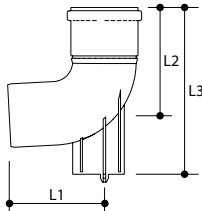

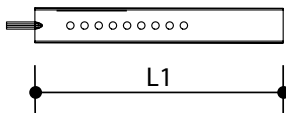

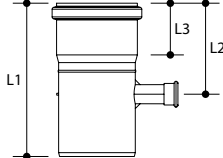

Direktlink zum vollständigen Dokument:
www.skoberne.eu

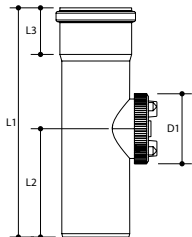

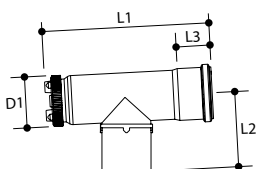

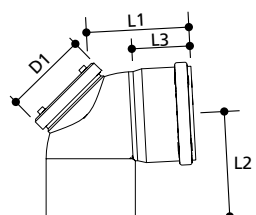

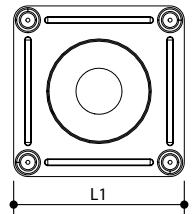
5 Einwandige Bauteile

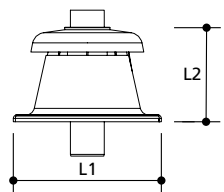
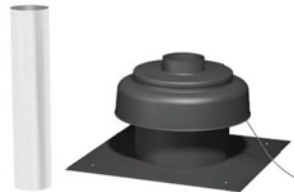
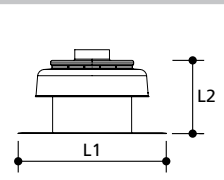
Rohr mit Muffe		NW	Art.Nr.	L1 (mm)	L2 (mm)	s (mm)	D1 (mm)
		L = 500 mm					
		60	021214	500	58	1,8	74
		80	020902	500	58	2,0	94
		110	001151	500	58	2,7	128
		125	000152	575	75	3,1	145
		160	000202	583	83	3,9	184
		200	000851	620	117	4,9	227
		250	002408	600	100	4,0	273
		L = 1000 mm					
		60	021216	1000	58	1,8	74
		80	020903	1000	58	2,0	94
		110	001152	1000	58	2,7	128
		125	000154	1075	75	3,1	145
		160	000204	1083	83	3,9	184
		200	000852	1120	117	4,9	227
		250	002407	1100	100	4,0	273
		L = 2000 mm					
		60	021218	1950	58	1,8	74
80	020905	1950	58	2,0	94		
110	001153	2000	58	2,7	128		
125	000156	2075	75	3,1	145		
160	000206	2083	83	3,9	184		
200	000853	2000	117	4,9	227		
250	002406	2100	100	4,0	273		
Abstandhalter		NW	Art.-Nr.	L1 (mm)	L2 (mm)	L3 (mm)	D1 (mm)
		60	001246	400			
		80	000662	400			
		110	000663	400			
		125	001805	400			
		160	002006	400			
		200	000871	400			
		250	002404	260			
Bogen mit Muffe 87 Grad							
		60	021242	110	120	55	
		80	020911	120	130	55	
		110	000113	115	117	58	
		125	000163	129	133	62	
		160	000213	156	161	71	
		200	000857	304	333	120	
		250	002411	384	387	100	
Bogen mit Muffe 45 Grad							
		60	021233	70	80	55	
		80	020908	90	90	55	
		110	000110	84	88	58	
		125	000160	100	100	62	
		160	000210	109	114	71	
		200	000856	181	181	120	
		250	002412	259	248	100	

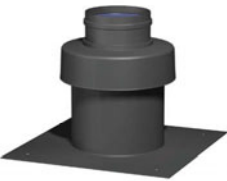
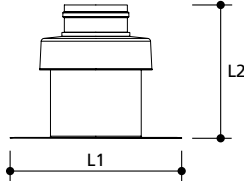
		NW	Art.-Nr.	L1 (mm)	L2 (mm)	L3 (mm)	D1 (mm)
Bogen mit Muffe 30 Grad							
		60	021235	70	80	55	
		80	021917	90	90	55	
		110	000109	80	90	59	
		125	000159	89	89	63	
		160	000209	104	103	70	
		200	000855	165	210	117	
		250	-----				
Bogen mit Muffe 15 Grad							
		60	021231	70	80	55	
		80	021916	90	90	55	
		110	000108	80	90	59	
		125	000158	75	78	63	
		160	000208	106	100	81	
		200	000854	153	197	117	
		250	-----				
Stützbogen mit Muffe 87 Grad							
		60	021240	110	120	180	
		80	020913	120	130	210	
		110	000121	115	117	215	
		125	000166	129	133	250	
		160	000216	156	161	296	
		200	000858	304	333	490	
		250	002401	384	387	710	
Auflageschiene							
		60	000327	350			
		80	000327	350			
		110	000327	350			
		125	000327	350			
		160	000327	350			
		200	000327	350			
		250	002402	650			
Abgasmessung							
		60	021239	175	95	55	
		80	020914	160	95	55	
		110	000123	220	95	57	
		125	000168	220	95	70	
		160	000218	263	110	81	
		200	000859	420	220	120	
		250	-----				

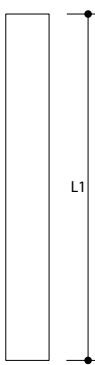

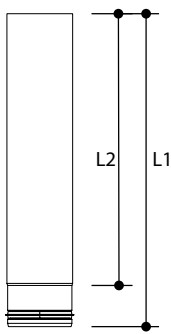
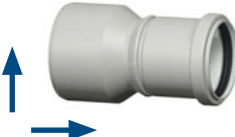
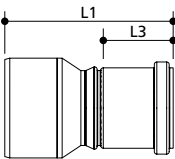

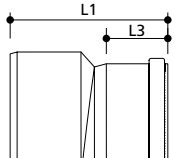



5 Einwandige Bauteile

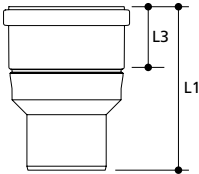
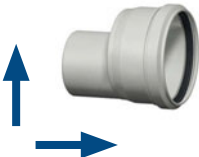
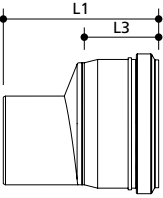

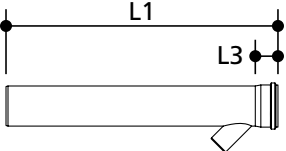

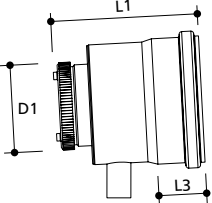

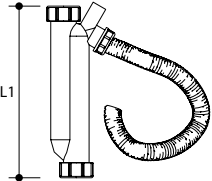

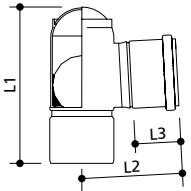

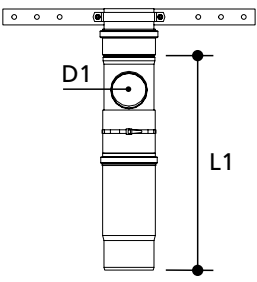
		NW	Art.-Nr.	L1 (mm)	L2 (mm)	L3 (mm)	D1 (mm)
Revisionsrohr mit Schraubdeckel							
		60	021250	250	120	55	75
		80	020915	270	128	58	75
		110	000124	274	134	75	105
		125	000179	280	143	72	105
		160	000230	329	162	78	105
		200	000861	420	220	120	105
		250	002410	600	353	100	150
Revisions-T-Stück							
		60	021249	250	100	55	75
		80	020916	272	124	58	75
Revisionbogen mit Schraubdeckel							
		110	001600	142	143	72	105
		125	001800	129	133	62	105
		160	002001	156	161	71	105
		200	000864	310	350	117	105
		250	002419	384	386	100	150
Belüftungsblende							
		60	001705	300			
		80	000918	300			
		110	000122	300			
		125	000167	300			
		160	000222	300			
		200	000876	400			
		250	002405				
Schachtabdeckung Kunststoff							
		60	001708	350	198		
		80	028001	350	198		
		110	001608	350	198		
Schachtabdeckung Edelstahl lackiert							
		60	001760	350	198		
		80	028090	350	198		
		110	002601	350	198		

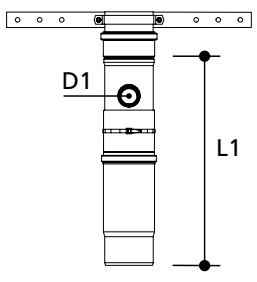
		NW	Art.-Nr.	L1 (mm)	L2 (mm)	L3 (mm)	D1 (mm)
Schachtabdeckung Metall							
		125	001804	350	270		
		160	002004	350	270		
		200	002204	480	267		
		250	002403	500	200		
Mündungsrohr VA blank 1000mm							
		60	001767	1000			
		80	028081	1000			
		110	002605	1000			
		125	001852	1000			
		160	002052	1000			
Mündungsrohr Verlängerung VA blank							
		60	001762	380	330		
		80	028089	380	330		
		110	002602	380	330		
Reduzierung symmetrisch							
		D 60/80	021256	135		55	
		D 80/75	000580	56		52	
		D 110/80	000956	153		55	
Reduzierung exzentrisch							
		D 110/80	001183	153		55	
		D 125/110	000172	158		67	
		D 160/110	000223	184		67	
		D 160/125	000221	180		75	
		D 200/160	001179	270		76	
		D 250/200	002400	310		117	

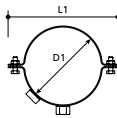
Hinweis: Die Pfeile zeigen die Durchströmrichtung der Abgase!
 Weitere Reduzierungen und Erweiterungen auf Anfrage

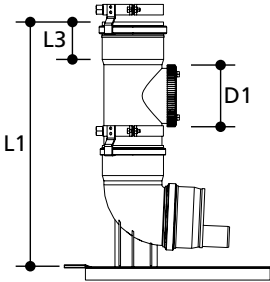

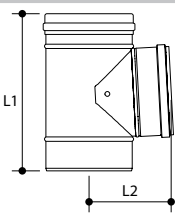





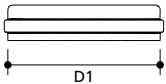

5 Einwandige Bauteile

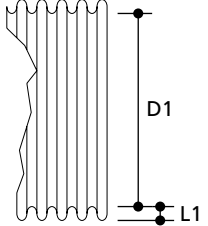
		NW	Art.-Nr.	L1 (mm)	L2 (mm)	L3 (mm)	D1 (mm)
Erweiterung symmetrisch							
		D 60/80	020933	135		56	
		D 75/80	020949	175		56	
		D 80/110	001932	165		55	
		D 100/110	000048	160		56	
		D 150/160	000429	185		71	
Erweiterung exzentrisch							
		D 60/75	001255	115		56	
		D 60/80	001714	135		58	
		D 80/110	000140	140		58	
		D 110/125	000174	180		65	
		D 125/160	000330	222		76	
		D 160/200	002030	310		117	
		D 200/250	002418	300		100	
Kaskadensammler							
		D 110/80	000678	1000		55	
		D 125/80	000677	1079		79	
		D 125/110	000676	1079		79	
		D 160/80	000675	1079		79	
		D 160/110	000674	1083		73	
		D 200/110	002216	1120		117	
		D 250/110	002415	675		100	
Abschlussdeckel mit Revision und Kondensatablauf							
		110	001173	185		60	100
		125	001801	185		62	100
		160	000595	196		76	
		200	000899	320		120	
		250	002417	452		100	
Sifon mit Schlauch 1 m							
		32	010073	250			
Rückströmsicherung							
		80	020878	196	118	58	
		110	000879	285	133	64	

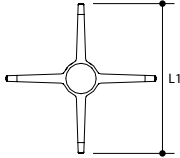

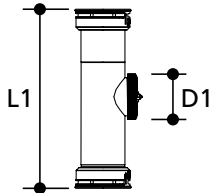

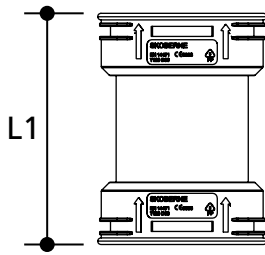

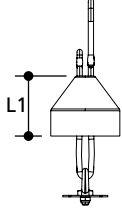

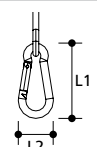

		NW	Art.-Nr.	L1 (mm)	L2 (mm)	L3 (mm)	D1 (mm)
MFB Kesselanschluss mit 80er Geräteanschluss							
		110	005610	530			80
		125	005630	520			80
		160	005635	550			80
MFB Kondensatanschluss mit 40er Abflussanschluss							
		110	005612	530			40
		125	005631	520			40
		160	005636	550			40
MFB Verbindungsschelle							
		110	005613	158			110
		125	005632	174			125
		160	005637	209			160
MFB Schachtsohle							
		110	005614	465		58	105
		125	005633	470		72	105
		160	005638	555		78	105
Rückströmsicherung							
		D 80/125	000672	234	118		
MFB Verschlusskappe für Abgas aus PPs							
		D 80	005617				80

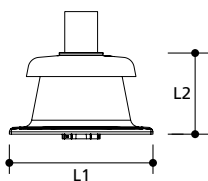
Hinweis: Die Pfeile zeigen die Durchströmrichtung der Abgase!
Weitere Reduzierungen und Erweiterungen auf Anfrage

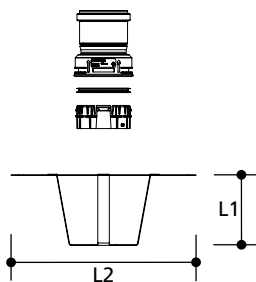

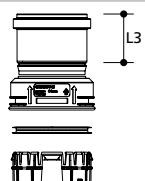

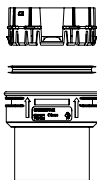

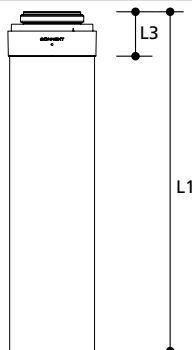



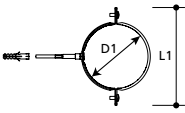

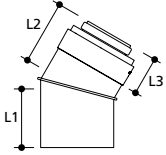

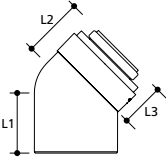
5 Flexible Bauteile

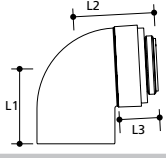

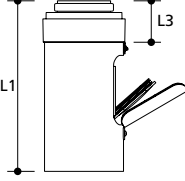

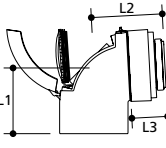

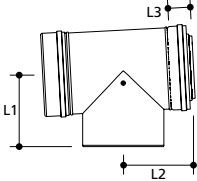

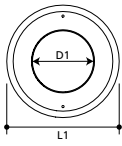

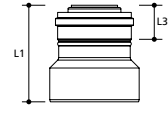

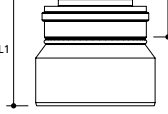
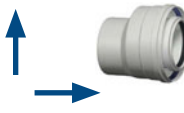
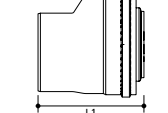

		NW	Art.-Nr.	L1 (mm)	L2 (mm)	L3 (mm)	D1 (mm)
MFB Verschlusskappe für Zuluft, Alu lackiert							
		D 125	001074				125
Flexible Abgasleitung							
		12,5 m	60	005811	8		50
			80	005841	12		76
		25,0 m	110	005872	12		101
			60	005813	8		50
			80	005843	12		76
			110	005873	12		101
Abstandhalter für flexible Abgasleitung							
		60	005802	400			
		80	005832	400			
		110	005862	400			
Revisionsrohr							
		60	015802	310			70
		80	015812	326			70
		110	015822	326			100
Verbindungsstück							
		60	015803	140			
		80	015813	140			
		110	015823	140			
Einziehhilfe							
		60	005805	75			
		80	005835	80			
		110	005865	85			

5 Konzentrische Bauteile

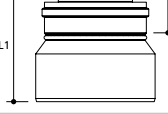
		NW	Art.-Nr.	L1 (mm)	L2 (mm)	L3 (mm)	D1 (mm)		
Seil für Einziehhilfe									
		25,0 Meter	005890	90	42				
Schachtabdeckung Kunststoff flex									
		60	015891	350	198				
		80	015892	350	198				
		110	015893	350	198				
Mündungsübergang von flex auf starr									
		60	015808	171	320				
		80	015838	171	320				
		110	015868	171	320				
Adapter flex auf starr									
		60	015806			55			
		80	015816			55			
		110	015826			59			
Adapter flex auf starr									
		60	015805						
		80	015815						
		110	015825						
Rohr konzentrisch									
		500 mm	60/100	001732	500		55		
			80/125	028057	500		55		
			110/150	001401	500		60		
		1000 mm	60/100	001731	1000		55		
			80/125	028056	1000		55		
			110/150	001402	1000		60		
		2000 mm	60/100	001730	1950		55		
			80/125	028055	1950		55		
			110/150	001403	1950		60		

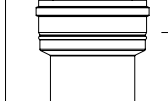

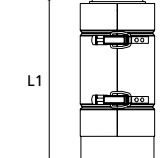

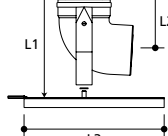



5 Konzentrische Bauteile

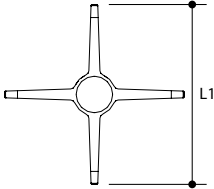

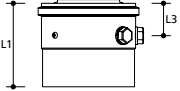

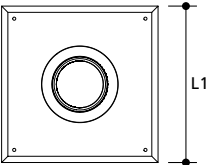

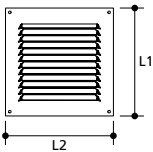
		NW	Art.-Nr.	L1 (mm)	L2 (mm)	L3 (mm)	D1 (mm)
Befestigungsschelle							
		60	001703	148			100
		80	600045	168			125
		110	001416	208			150
Bogen konzentrisch 30°							
		60/100	001738	85	95	55	
		80/125	028060	100	110	55	
		110/150	001405	100	110	60	
Bogen konzentrisch 45°							
		60/100	001737	70	80	55	
		80/125	028059	90	90	55	
		110/150	001406	110	110	60	
Bogen konzentrisch 90°							
		60/100	001736	110	120	55	
		80/125	028058	120	130	55	
		110/150	001407	165	174	60	
Revisionsrohr konzentrisch							
		60/100	001735	250		55	
		80/125	028092	270		55	
		110/150	001408	270		60	
Revisionsbogen konzentrisch							
		60/100	001743	110	120	55	
		80/125	028093	120	130	55	
Revisions-T-Stück konzentrisch							
		110/150	001409	140	130	65	
Mauerblende							
		60/100	001282	194			100
		80/125	000944	230			125
		110/150	001412	230			150

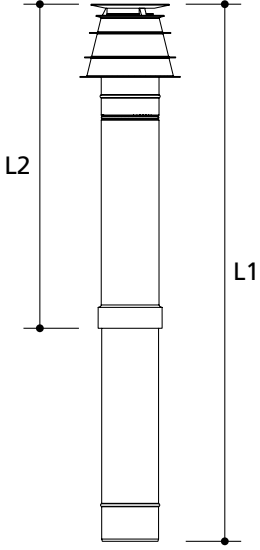
		NW	Art.-Nr.	L1 (mm)	L2 (mm)	L3 (mm)	D1 (mm)
Reduzierung symmetrisch							
		80/125 – 60/100	021270	135		55	
Reduzierung symmetrisch							
		100/150 – 80/125	001320	140		56	
Erweiterung symmetrisch							
		60/100 – 80/125	001298	135		55	
Reduzierung symmetrisch							
		110/150 – 80/125	001322	135		56	
Erweiterung exzentrisch							
		60/100 – 80/125	001304	135		58	
Reduzierung symmetrisch							
		110/160 _ 110/150	001321	175		65	
Erweiterung symmetrisch							
		80/125 – 110/150	001305	165		60	
Trennstück							
		60/100	001704	255			
		80/125	020929	255			
		110/150	001415	255			
Stützbogen							
		60/100	001719	200	120	350	
		80/125	028016	225	136	350	
		110/150	001438	255	174	350	

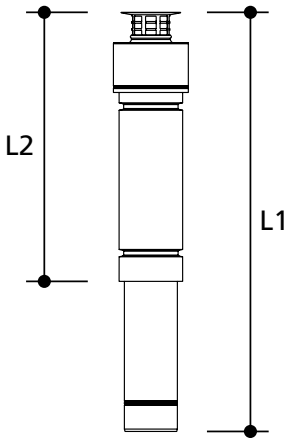

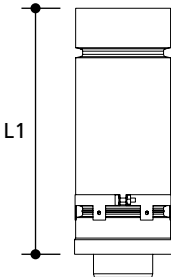

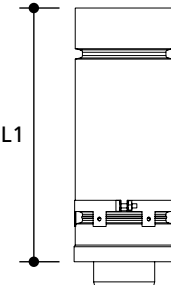

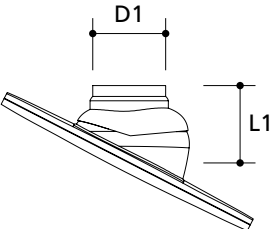



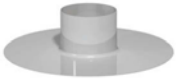
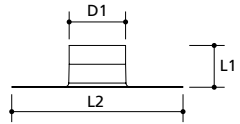

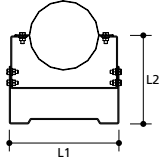

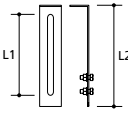
Hinweis: Die Pfeile zeigen die Durchströmrichtung der Abgase!
Weitere Reduzierungen und Erweiterungen auf Anfrage

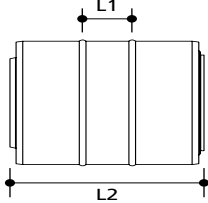
5 Konzentrische Bauteile

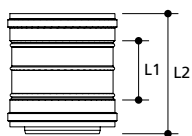

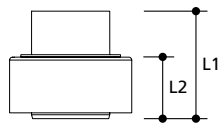

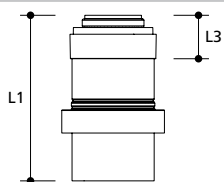

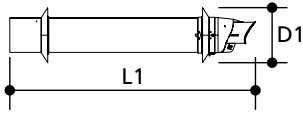



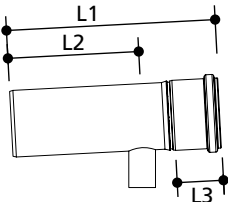

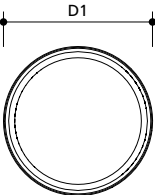
		NW	Art.-Nr.	L1 (mm)	L2 (mm)	L3 (mm)	D1 (mm)
Abstandhalter							
		60/100	001700	400			
		80/125	002005	400			
Kesselanschluss- / Messstück							
		60/100	001269	250		95	
		80/125	020931	119		49	
		110/150	001432	175		95	
Kondensatablauf							
		60/100	001766				
		80/125	000932				
		110/150	001435				
Raumluftverbundblende							
		60/100	001283	250			
		80/125	028063	250			
		110/150	001437	250			
Zuluftgitter							
			010021	300	250		
Dachdurchführung schwarz / rot							
		60/100	021276- 021278	1185	715		
		80/125	020950- 020951	1185	715		

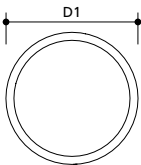
		NW	Art.-Nr.	L1 (mm)	L2 (mm)	L3 (mm)	D1 (mm)
Dachdurchführung schwarz / rot							
		110/150	001410-001411	1195	775		
Überdachverlängerung 500mm schwarz / rot							
		60/100 – 80/125	001920-001921	525			
		110/150	001418-001419	455			
Überdachverlängerung 1000mm schwarz / rot							
		60/100 – 80/125	001922-001923	1000			
Schrägdachpfanne schwarz / rot							
		60/100 – 80/125	000436-000388	140			131,5
		110/150	000309-000389	140			

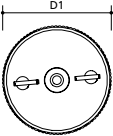

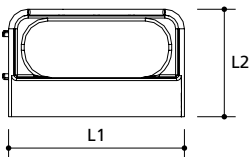

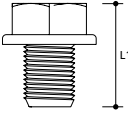

5 Konzentrische Bauteile

		NW	Art.-Nr.	L1 (mm)	L2 (mm)	L3 (mm)	D1 (mm)
Flachdachkragen							
		60/100 – 80/125	000242	100	410		135
		110/150	000322	150	470		170
Wandschelle verstellbar							
		100	001768	175	100 - 140		
		125	600107	195	106 - 160		
		150	001417	235	134 - 186		
Verlängerung für Wandschelle							
			600109	132	160		
Adapternippel von Innen- zu Außenwandsystem							
		110/150	001422	45	175		
Adaptermuffe für Dachdurchführung							
		110/150	001423	85	165		
Außenwand-Mündung							
		60/100	001739	110	57		
		80/125	028050	110	57		
		110/150	001414	90	61		
Außenwand-Luftansaugstück							
		60/100	001740	250		55	
		80/125	028061	250		55	
		110/150	001413	175		60	
Mauerdurchführung							
		60/100	021280	954			160
		80/125	028104	952			220

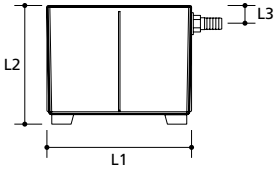
5 Zubehör

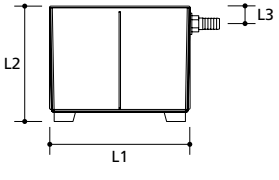
		NW	Art.-Nr.	L1 (mm)	L2 (mm)	L3 (mm)	D1 (mm)
Kondensatablauf							
		80	020965	250	155	56	
		110	000125	220	115	60	
		125	000170	220	115	60	
		160	000220	263	148	68	
		200	000863	420	220	120	
Lippendichtung							
		60	001253				60
		80	001980				80
		110	001693				110
		125	001802				125
		160	002003				160
		200	002200				200
		250	002420				250
Flachdichtung							
		75	000424				75
		105	000425				105
Revisionsdeckel							
		81	020587				83
		115	001158				117
Revisionschlüssel							
			000049	90	55		
Verschluss- Schraube für Messstelle							
		M12	001113	25			
Verschluss- Kappe für Messstelle							
		M12	000830	14,5			

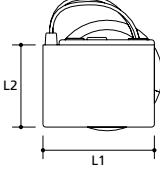
5 Zubehör

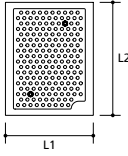
		NW	Art.-Nr.	L1 (mm)	L2 (mm)	L3 (mm)	D1 (mm)
Neutralisationseinheit Gas							
			000510	244	200	30	
Neutralisationseinheit Öl							
			010152	244	200	30	
Kondensat- Hebepumpe							
			000514	168	118		
Feinfiltersieb							
			010075	140	180		

6 Anhang

A Kunststoff-Schachtabdeckung (flex)



6 Anhang

B *Metallische Schachtabdeckung (flex) mit Mündungsübergang*

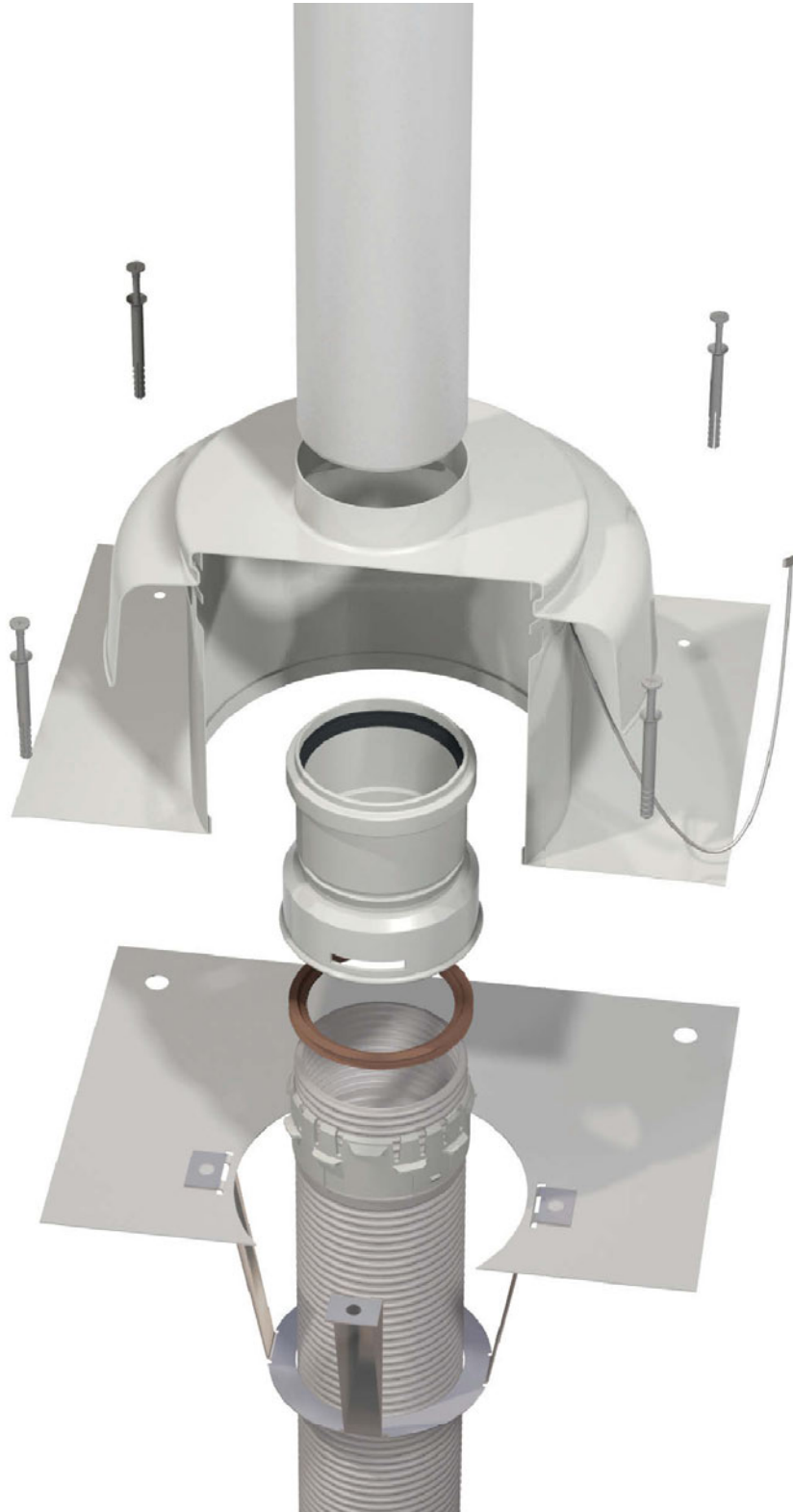

C Verstellbare Wandschelle

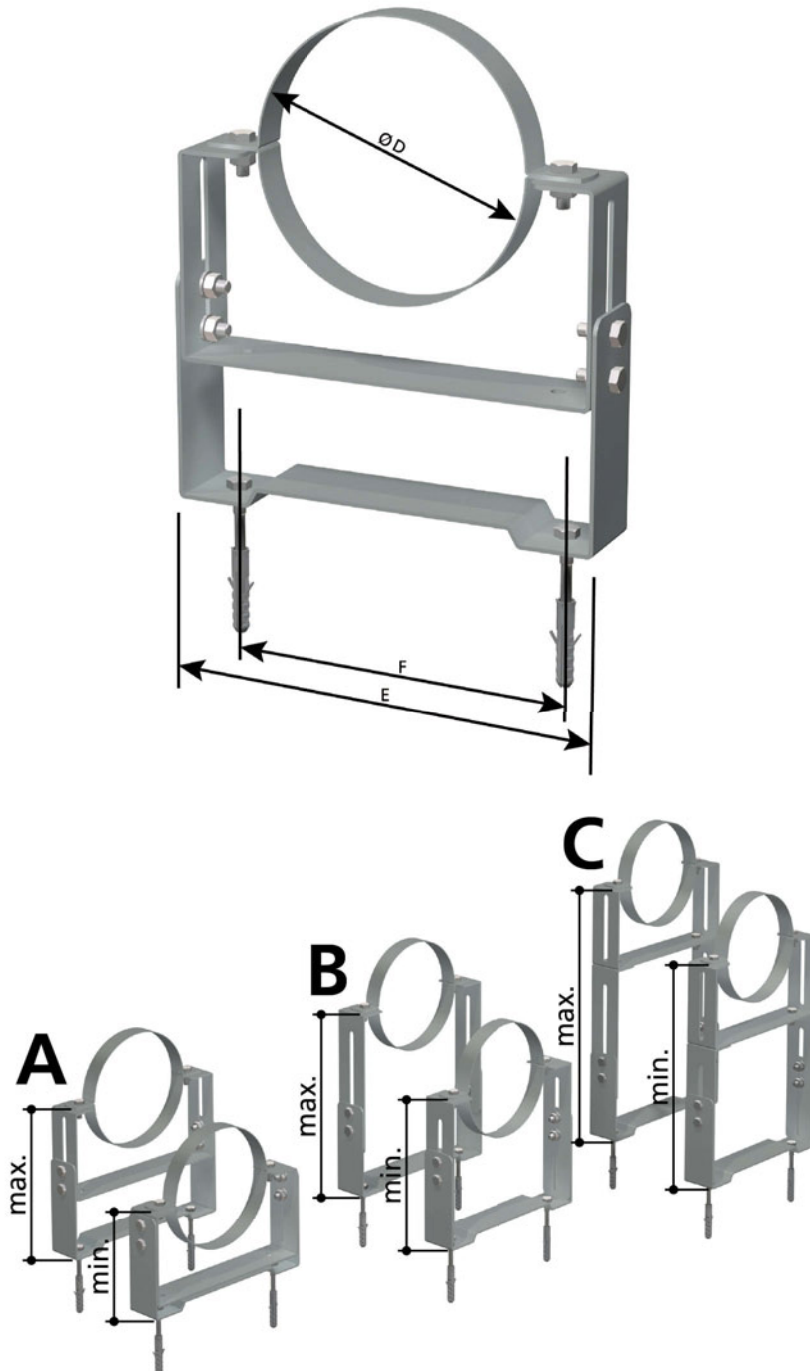

	A min.	A max.	B min.	B max.	C min.	C max.	E	F
D 100	100	140	165	215	250	300	175	135
D 125	106	160	163	225	260	320	195	165
D 150	134	186	164	243	287	365	235	195

Stempel Händler

SKOBERNE GmbH
Ostendstraße 1
64319 Pfungstadt
Telefon (06157) 80700
Telefax (06157) 807070
E-Mail: info@skoberne.de
www.skoberne.de

Technische Änderungen vorbehalten

DOK101.00, 10/13