

UNIFIX

Chimney components and shaft for flue pipes

FLEXIBLE
universal planning
and handling

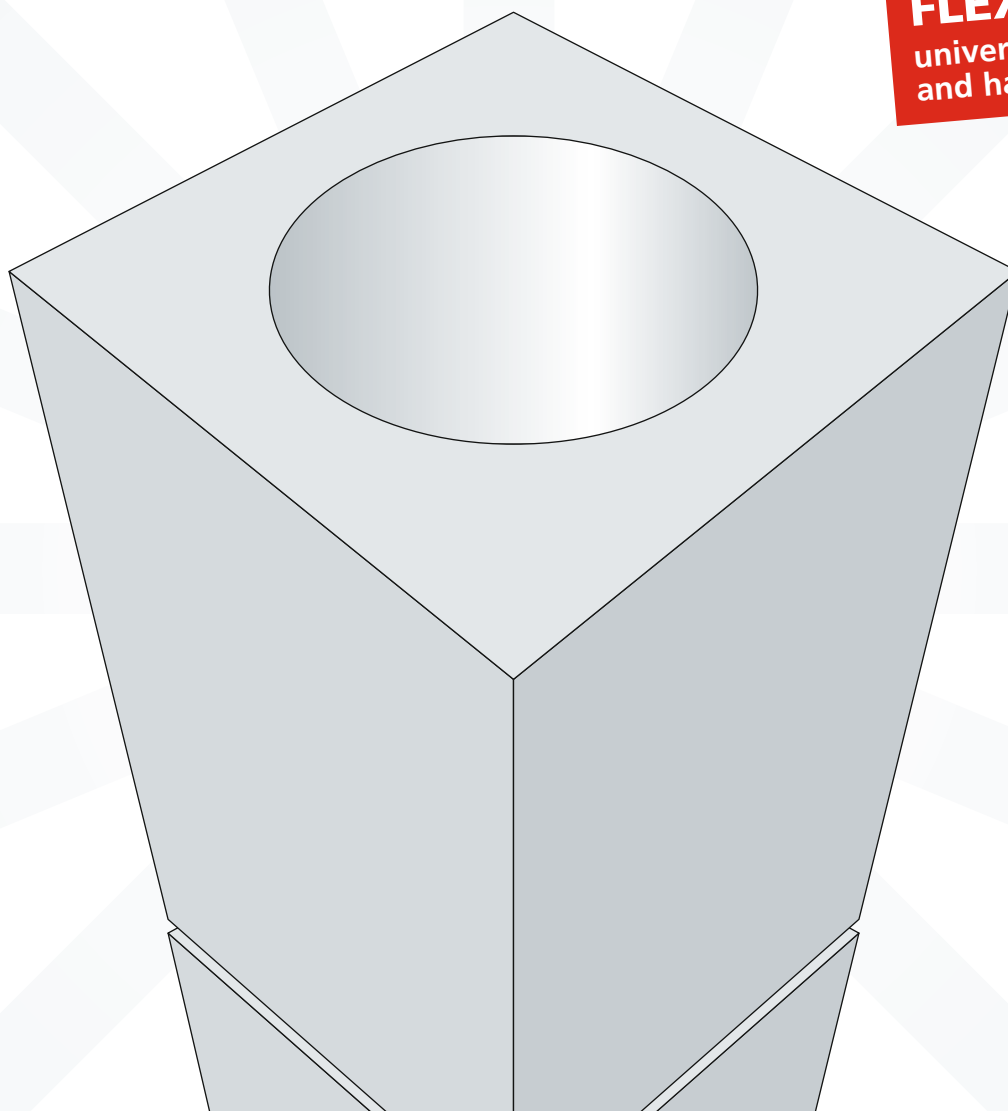

The application is your choice

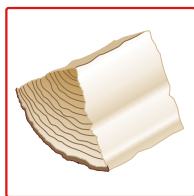
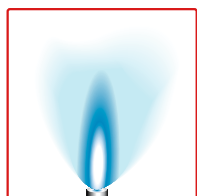

UNIFIX in detail

An overview of the UNIFIX building material

- UNIFIX-formed bricks for ductwork are made of autoclaved aerated concrete with an average density of 0.5 kg/dm³, and are therefore particularly light.
- Attachments and cut-outs can be easily made using commercially available tools.
- UNIFIX-formed bricks for ductwork have square outer dimensions, and a circular bore hole
- Easy bonding with thin bed mortar
- UNIFIX-formed bricks for ductwork are approved both for the construction of "pre-assembled chimneys" as well as for the erection of duct work for flue gas pipes (general construction approval as ductwork and general construction approval as chimney work)
- Fire resistance of UNIFIX-formed bricks for ductwork: 90 mins.

The system, flexible and universal applicable

UNIFIX-formed bricks are approved for ductwork and for the construction of shafts for flue gas pipes. The General Appraisal Certificate no. Z-7.4-3433 as well as the General Technical Approval no. Z-7.1-3048 confirm the suitability.

The shaft is offering a fire resistance duration of 90 minutes. This provides enormous advantages for chimney builders. For this reason it is quite simple and secure to calculate the storage and the applications.

UNIFIX is available in five standard sizes

UNIFIX 165

- Exterior dimensions 240 x 240 mm, height 500 mm
- Open inner diameter 165 mm
- For use with exhaust gas pipes under positive or negative pressure operation as well as for single-wall and concentric exhaust gas lines

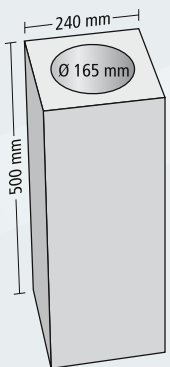

... as a shaft for plastic flue sections – balanced flue system

UNIFIX 210

- Exterior dimensions 300 x 300 mm, height 500 mm
- Open inner diameter 210 mm
- For the use with larger-dimensioned exhaust gas lines as well as for incorporation of suitable exhaust gas systems from pellet furnaces

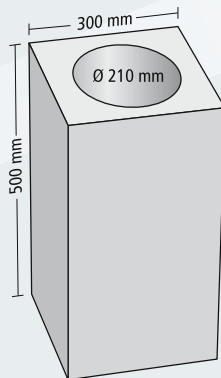

... as a shaft for either single-wall or concentric flue sections, as well as communal flues

UNIFIX 240, UNIFIX 280 und UNIFIX 325

- Exterior dimensions 360 x 360 mm, 400 x 400 mm and 450 x 450 mm, all height 250 mm
- Open inner diameters 240 mm, 280 mm and 325 mm
- For use in larger exhaust gas systems
- Despite their small size, these formed bricks still provide sufficient interior space for the uptake of chimney feed pipes for operation with solid fuel pipes
- Optimal application for domestic chimney construction, particularly where the fuel and combustion technology are not yet clearly defined

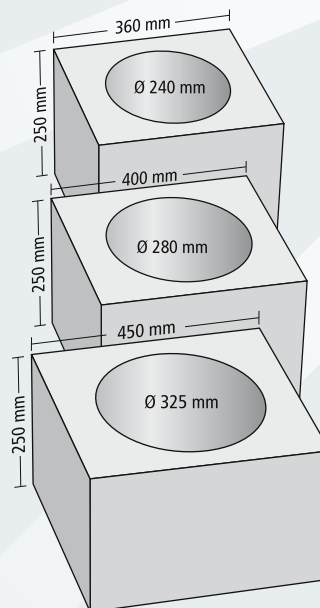

... as a shaft for flue systems of pellet-fired heaters, stoves and PP flue sections of up to 200 mm

Typical applications

Examples of the use of **UNIFIX** as a shaft system in connection with equipment operating at overpressure and underpressure and as a flue for waste gases released on combustion of solid fuels, such as pellets

For use on combustion of solid fuels, such as wood, pellets or coal to T 400

The roof terminal

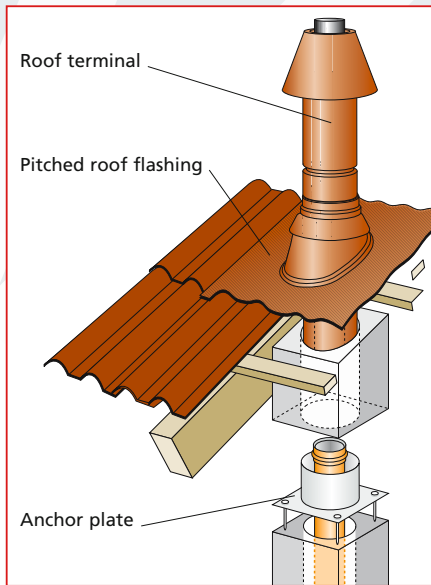

The roof terminal is available in two lengths and colours. The incline of the roof flashing can be adjusted as required. **UNIFIX** is thus suitable for nearly all roofs.

Exhaust gas pipe for oil and gas heat sources to T 160 operating at overpressure (complete system)

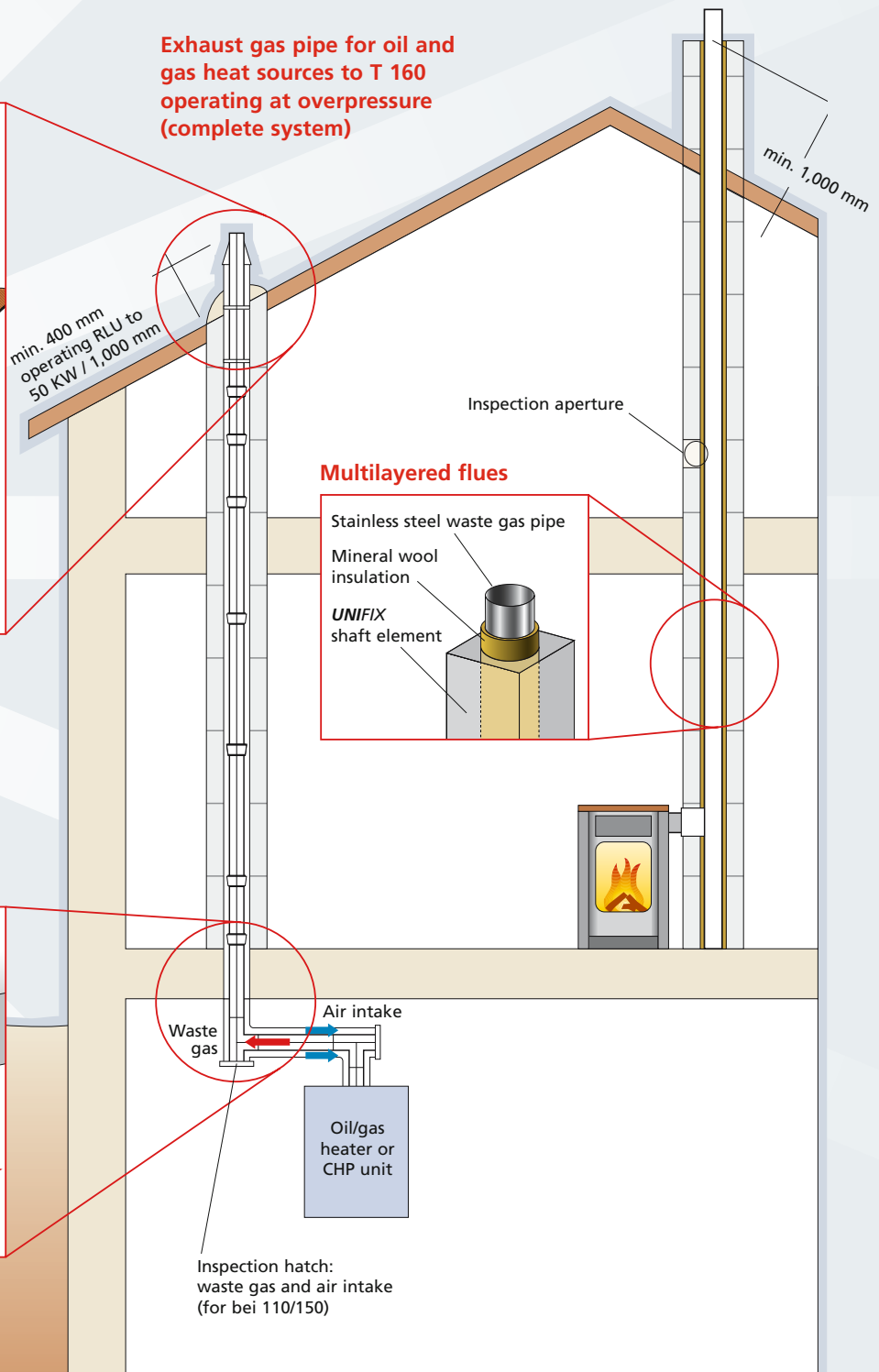

Multilayered flues

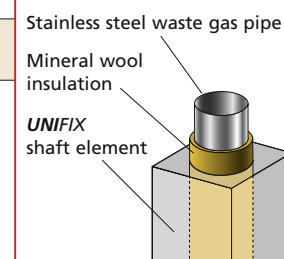

The ceiling connection element

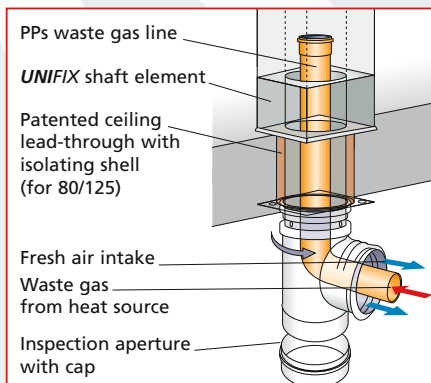

The patented ceiling connection element allows simple and straight-forward inspection of the annular gap and the waste gas line from below. Additional fittings, such as a roof hatch, are no longer necessary.

UNIFIX

All advantages at a glance

identification	measurements [mm]			weight per piece [kg]	fire resistance duration [min]	test certificate/ general technical approval
	length x width	height	clear cross-section			
UNIFIX 165	240 x 240	500	165	9.6	90	Z-7.4-3433
UNIFIX 210	300 x 300	500	210	14.7	90	Z-7.4-3433 Z-7.1-3048
UNIFIX 240	360 x 360	250	240	10.5	90	Z-7.4-3433 Z-7.1-3048
UNIFIX 280	400 x 400	250	280	11.5	90	Z-7.4-3433 Z-7.1-3048
UNIFIX 325	450 x 450	250	325	17.0	90	Z-7.4-3433

Subject to technical modifications.

Universally applicable

- Applicable for condensing operation up to T160 or solid fuel technology up to T400
- Fire resistance duration: 90 minutes
- Small outside dimensions
- 5 standard sizes for easy stocking and precise calculation
- Large-scale accessories
- General technical approval and certification

Fast and easy to assemble

- Height of shaft elements up to 500 mm
- Light weight gas concrete – up to 75% weight saving
- Easy to handle on-site with standard tools
- Simple connection with thin-bed mortar
- Easy implementation of the roof-duct
- Room saving installation from ground floor above installation room of the condensing boiler up to the roof area. (only the complete UNIFIX system incl. the Skoberne flue pipe and the bracing brackets)

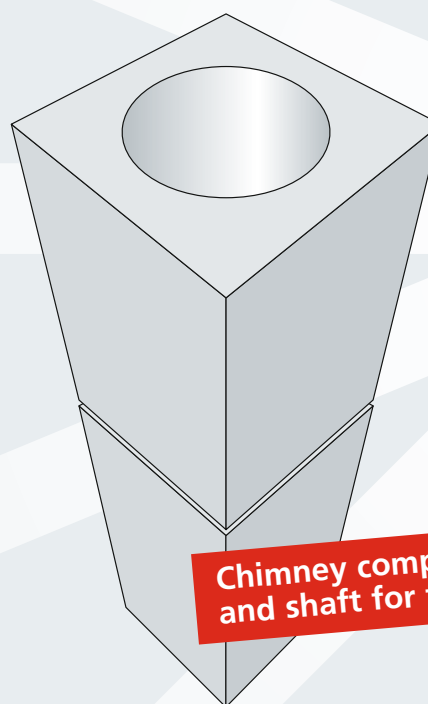

Chimney components
and shaft for flue pipes

Handed over by:

Last amended June 2020. Item no. 791042EN